



2015-2018

BoXXer<sup>®</sup> World Cup



Service Manual



# SRAM® LLC WARRANTY

## EXTENT OF LIMITED WARRANTY

Except as otherwise set forth herein, SRAM warrants its products to be free from defects in materials or workmanship for a period of two years after original purchase. This warranty only applies to the original owner and is not transferable. Claims under this warranty must be made through the retailer where the bicycle or the SRAM component was purchased. Original proof of purchase is required. **Except as described herein, SRAM makes no other warranties, guaranties, or representations of any type (express or implied), and all warranties (including any implied warranties of reasonable care, merchantability, or fitness for a particular purpose) are hereby disclaimed.**

## LOCAL LAW

This warranty statement gives the customer specific legal rights. The customer may also have other rights which vary from state to state (USA), from province to province (Canada), and from country to country elsewhere in the world.

To the extent that this warranty statement is inconsistent with the local law, this warranty shall be deemed modified to be consistent with such law, under such local law, certain disclaimers and limitations of this warranty statement may apply to the customer. For example, some states in the United States of America, as well as some governments outside of the United States (including provinces in Canada) may:

- a. Preclude the disclaimers and limitations of this warranty statement from limiting the statutory rights of the consumer (e.g. United Kingdom).
- b. Otherwise restrict the ability of a manufacturer to enforce such disclaimers or limitations.

## For Australian customers:

This SRAM limited warranty is provided in Australia by SRAM LLC, 1000 W. Fulton Market, 4th Floor, Chicago, IL, 60607, USA. To make a warranty claim please contact the retailer from whom you purchased this SRAM product. Alternatively, you may make a claim by contacting SRAM Australia, 6 Marco Court, Rowville 3178, Australia. For valid claims SRAM will, at its option, either repair or replace your SRAM product. Any expenses incurred in making the warranty claim are your responsibility. The benefits given by this warranty are additional to other rights and remedies that you may have under laws relating to our products. Our goods come with guarantees that cannot be excluded under the Australian Consumer Law. You are entitled to a replacement or refund for a major failure and for compensation for any other reasonably foreseeable loss or damage. You are also entitled to have the goods repaired or replaced if the goods fail to be of acceptable quality and the failure does not amount to a major failure.

## LIMITATIONS OF LIABILITY

To the extent allowed by local law, except for the obligations specifically set forth in this warranty statement, in no event shall SRAM or its third party suppliers be liable for direct, indirect, special, incidental, or consequential damages.

## LIMITATIONS OF WARRANTY

This warranty does not apply to products that have been incorrectly installed and/or adjusted according to the respective SRAM user manual. The SRAM user manuals can be found online at [sram.com](http://sram.com), [rockshox.com](http://rockshox.com), [avidbike.com](http://avidbike.com), [truvatv.com](http://truvatv.com), or [zipp.com](http://zipp.com).

This warranty does not apply to damage to the product caused by a crash, impact, abuse of the product, non-compliance with manufacturers specifications of usage or any other circumstances in which the product has been subjected to forces or loads beyond its design.

This warranty does not apply when the product has been modified, including, but not limited to any attempt to open or repair any electronic and electronic related components, including the motor, controller, battery packs, wiring harnesses, switches, and chargers.

This warranty does not apply when the serial number or production code has been deliberately altered, defaced or removed.

This warranty does not apply to normal wear and tear. Wear and tear parts are subject to damage as a result of normal use, failure to service according to SRAM recommendations and/or riding or installation in conditions or applications other than recommended.

## Wear and tear parts are identified as:

- |   |  |                          |                      |
|---|--|--------------------------|----------------------|
| • Dust seals                                  | • Stripped threads/bolts (aluminium, titanium, magnesium or steel) | • Handlebar grips        | • Transmission gears |
| • Bushings                                    | • Brake sleeves  | • Shifter grips          | • Spokes             |
| • Air sealing o-rings                         | • Brake pads   | • Jockey wheels          | • Free hubs          |
| • Glide rings                                 | • Chains   | • Disc brake rotors      | • Aero bar pads      |
| • Rubber moving parts                         | • Sprockets  | • Wheel braking surfaces | • Corrosion          |
| • Foam rings                                  | • Cassettes  | • Bottomout pads         | • Tools              |
| • Rear shock mounting hardware and main seals | • Shifter and brake cables (inner and outer)                       | • Bearings               | • Motors             |
| • Upper tubes (stanchions)                    |  | • Bearing races          | • Batteries          |
|   |  | • Pawls                  |                      |

**Notwithstanding anything else set forth herein**, the battery pack and charger warranty does not include damage from power surges, use of improper charger, improper maintenance, or such other misuse.

This warranty shall not cover damages caused by the use of parts of different manufacturers.

This warranty shall not cover damages caused by the use of parts that are not compatible, suitable and/or authorised by SRAM for use with SRAM components.

This warranty shall not cover damages resulting from commercial (rental) use.

# TABLE OF CONTENTS

<b>BOXXER® WORLD CUP EXPLODED VIEW .....</b>	<b>5</b>
<b>ROCKSHOX® SUSPENSION SERVICE .....</b>	<b>6</b>
PARTS AND TOOLS NEEDED FOR SERVICE .....	6
RECORD YOUR SETTINGS .....	7
SERVICE INTERVAL INFORMATION .....	7
BOXXER TORQUE CHART .....	7
BOXXER OIL VOLUME .....	7
<b>FORK REMOVAL.....</b>	<b>8</b>
<b>LOWER LEG REMOVAL.....</b>	<b>10</b>
LOWER LEG SEAL SERVICE .....	13
<b>SOLO AIR™ SPRING SERVICE.....</b>	<b>16</b>
AIR SPRING REMOVAL .....	16
SOLO AIR BOTTOMLESS TOKEN™ INSTALLATION.....	20
AIR SPRING INSTALLATION .....	21
<b>CHARGER DAMPER™ SERVICE .....</b>	<b>23</b>
CHARGER DAMPER REMOVAL .....	23
<b>OPTIONAL CHARGER DAMPER RE-TUNE.....</b>	<b>32</b>
OPTIONAL REBOUND RE-TUNE .....	32
OPTIONAL COMPRESSION RE-TUNE .....	35
<b>CHARGER DAMPER ASSEMBLY AND BLEED .....</b>	<b>39</b>
<b>LOWER LEG ASSEMBLY .....</b>	<b>49</b>
<b>FORK INSTALLATION .....</b>	<b>52</b>



## **SAFETY FIRST!**

We care about YOU. Please, always wear your safety glasses and protective gloves when servicing RockShox® products.  
Protect yourself! Wear your safety gear!

# BoXXer® World Cup Exploded View

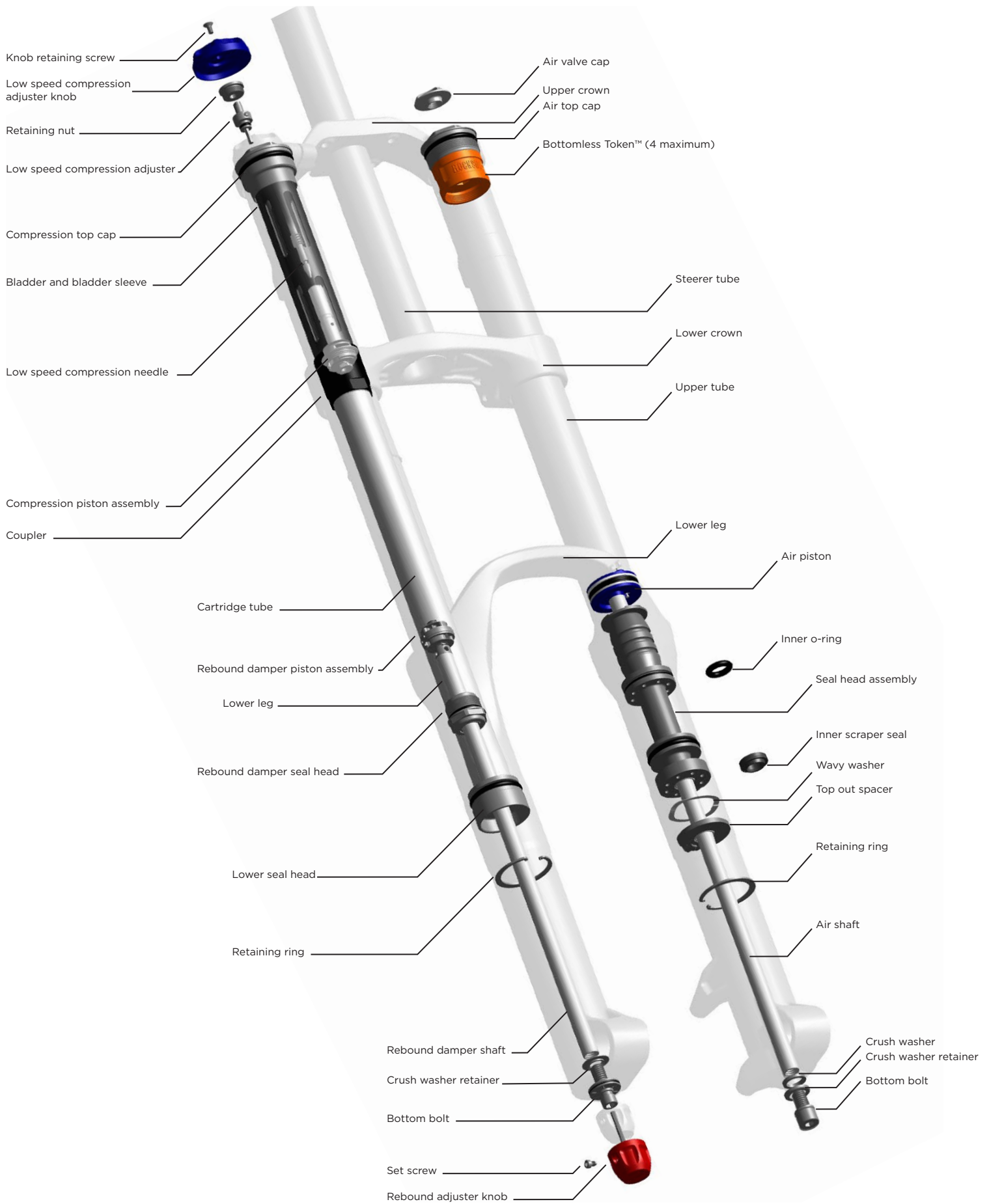

## RockShox® Suspension Service

We recommend that you have your RockShox suspension serviced by a qualified bicycle mechanic. Servicing RockShox suspension requires knowledge of suspension components as well as the special tools and fluids used for service.

For exploded diagram and part number information, please refer to the Spare Parts Catalog available on our website at [www.sram.com/service](http://www.sram.com/service). For order information, please contact your local SRAM® distributor or dealer.

Information contained in this publication is subject to change at any time without prior notice. For the latest technical information, please visit our website at [www.sram.com/service](http://www.sram.com/service).

**Your product's appearance may differ from the pictures contained in this publication.**

### Parts and Tools Needed for Service

- Safety glasses
- Nitrile gloves
- Apron
- Clean, lint-free rags
- Oil pan
- Isopropyl alcohol
- Bicycle stand
- Bench vise with aluminum soft jaws
- RockShox 3wt suspension fluid
- RockShox 0w-30 suspension fluid
- SRAM Butter suspension grease
- Shock pump
- 35 mm seal installation tool
- Downhill tire lever
- Plastic mallet
- Flat head screwdriver
- Diagonal cutter (26" fork)
- Schrader valve core tool
- (2) 21, 23, and 25 mm open end wrenches
- 21, 23, and 25 mm crowfoot wrenches
- 2, 2.5, 4, 5, 6, and 8 mm hex wrenches
- 5/8", 2, 2.5, 4, 5, and 6 mm hex bit sockets
- 6, 10, 15, and 24 mm socket wrenches
- Torque wrench
- Needle-nose pliers
- Large internal snap ring pliers
- Pick
- Long plastic or wooden dowel
- RockShox syringe with Charger™ bleed tip
- Loctite® Threadlocker Blue 242™
- Loctite Threadlocker Red 2760™
- Metric calipers (for re-tuning shim stacks)
- RockShox Rear Shock Vise Block (for re-tuning shim stacks)
- Cable tie (26" fork)

### SAFETY INSTRUCTIONS

Always wear nitrile gloves when working with suspension fluid and bicycle grease.

Place an oil pan on the floor underneath the area where you will be working on the fork.

## Record your Settings

Use the charts below to record your BoXXer® fork settings to return your fork to its pre-service settings. Record your service date to track service intervals.

Service date - helps you keep track of service intervals.	
Air pressure - use a shock pump to determine how much air pressure is in your air spring.	
Dual Crown height - measure the distance from the top of the upper to tube to the top of the lower crown (see figure in Step 1).	
Rebound setting - count the number of clicks while turning the rebound adjuster fully counter-clockwise.	
Compression setting - count the number of clicks while turning the compression adjuster fully counter-clockwise.	

## Service Interval Information

Maintenance	Interval (hours)
Clean dirt and debris from upper tubes	Every ride
Check air pressure	Every ride
Inspect upper tubes for scratches	Every ride
Check front suspension fasteners for proper torque	25
Remove lowers, clean/inspect bushings and change oil bath	50
Clean and lubricate air spring assembly	100
Change oil in damping system	100

## BoXXer Torque Chart

Part	Tool	Torque
Maxle Lite DH™ (non-drive side)	6 mm hex bit socket	3.4 N•m (30 in-lb)
Maxle Lite DH (drive side)	6 mm hex bit socket	5.7 N•m (50 in-lb)
Crown bolts	4 mm hex bit socket	5 N•m (44 in-lb)
Bottom bolts	5 mm hex bit socket	7.3 N•m (65 in-lb)
Top caps	24 mm socket	7.3 N•m (65 in-lb)

## BoXXer Oil Volume

Part	Oil Weight	Volume (mL)
Drive side lower leg	0w-30	10
Non-drive side lower leg		
Drive side upper tube	3wt	Bleed (varies)
Non-drive side upper tube	SRAM® Butter	

## Fork Removal

We recommend the following steps to remove your BoXXer® fork from the bicycle. Removing the fork from the bicycle provides easy access to internal components and is more convenient than working around a complete bicycle.

- 1 To assist you with post-service assembly, record the distance from the top of the upper tube to the top of the lower crown.



- 2 Use a 6 mm hex wrench to loosen the non-drive side bolt of the Maxle Lite DH™ until detent clicks are no longer felt.

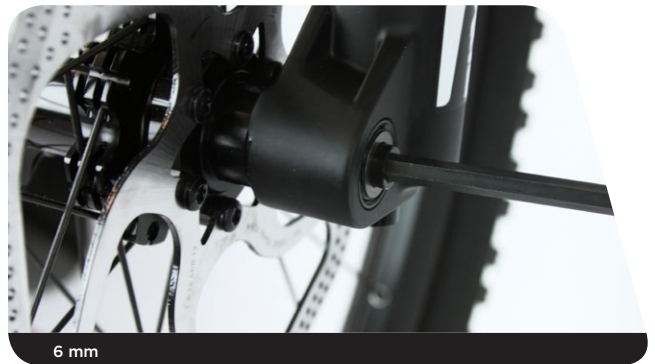

- 3 Use a 6 mm hex wrench to remove the Maxle Lite DH from the drive side of the fork. Pull the wheel down to remove it from the fork.



- 4 **27.5" forks:** Use a 2.5 mm hex wrench to remove the brake hose from the hose brace on the fork arch.

**26" forks:** Use a diagonal cutter to cut the cable tie holding the brake hose to the fork arch.

Remove the brake caliper according to the brake manufacturer's instructions.





- 5 Use a 4 mm hex wrench to loosen the four lower crown and two upper crown pinch bolts clamping the upper tubes.

**Do not loosen the steerer tube clamping bolt located on the upper crown.**



- 6 Slide the upper tubes down so they clear the upper crown. Leave enough clearance between the upper tube and upper crown to remove the frame bumpers.

Use a 4 mm hex wrench to tighten one of the lower crown bolts to temporarily hold the tubes in place while you remove the frame bumpers.

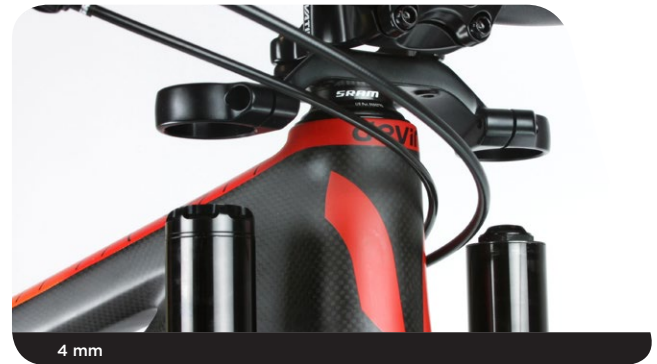

- 7 Use your thumb to pry the thickest section of each frame bumper away from the upper tube. Spray isopropyl alcohol or water between each bumper and upper tube. Twist the frame bumpers back and forth until they are loose on the upper tubes.

Remove the frame bumpers from the upper tubes.



- 8 Use a 4 mm hex wrench to loosen the lower crown bolt. Slide the tubes through the lower crown and remove the fork from the bicycle.

Spray isopropyl alcohol on the upper tubes and crown clamping surface and clean them with a rag.

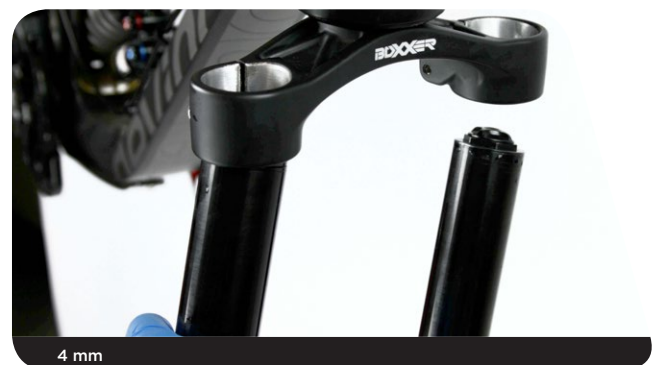

## Lower Leg Removal

- 1 Clamp the non-drive side upper tube into a bicycle stand.



- 2 Remove the air valve cap from the top cap located on the non-drive side fork leg.

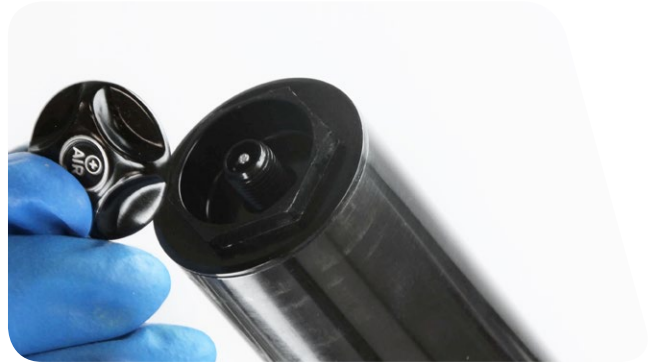

- 3 Use a small hex wrench to depress the Schrader valve and release all air pressure from the air chamber.

### **⚠ CAUTION - EYE HAZARD**

Verify all pressure is removed from the fork before proceeding. Failure to do so can result in injury and/or damage to the fork. Wear safety glasses.



- 4 Use a 5 mm hex wrench to loosen the non-drive side bottom bolt 3 to 4 turns.



- 5** Place an oil pan beneath the fork to catch any draining fluid. Use a plastic mallet to firmly strike the non-drive side bottom bolt to dislodge the air shaft from the lower leg.

Use a 5 mm hex wrench to remove the bottom bolt from the lower leg.



- 6** Firmly pull the lower leg downward until fluid begins to drain. Continue pulling downward to remove the lower leg from the non-drive side upper tube.

If the lower leg does not slide off of the upper tube, then the press-fit of the shaft to the lower leg may still be engaged. Reinstall the bottom bolt 2 to 3 turns and repeat steps 4-6.

### NOTICE

Do not hit the fork arch with any tool when removing the lower leg as this could damage the lower leg.



- 7** Clamp the drive side upper tube into a bicycle stand.



- 8** Use a 2.5 mm hex wrench to loosen the set screw and remove the rebound adjuster knob located at the bottom of the drive side lower leg.

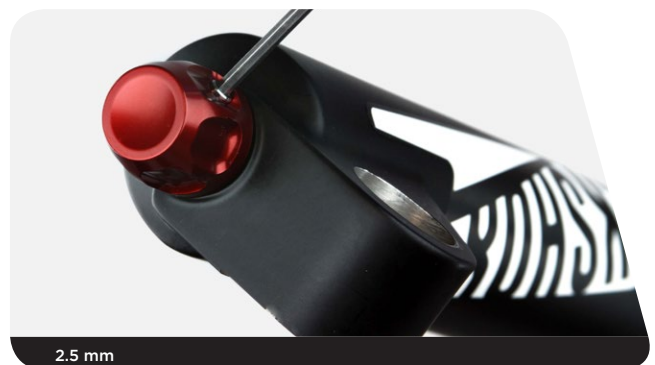

- 9 Use a 5 mm hex wrench to loosen the drive side bottom bolt 3 to 4 turns.



- 10 Place an oil pan beneath the fork to catch any draining fluid. Use a plastic mallet to firmly strike the drive side bottom bolt to dislodge the rebound damper shaft from the lower leg. Use a 5 mm hex wrench to remove the bottom bolt from the lower leg. **Do not dislodge the silver casting plug from the drive side lower leg.**



- 11 Firmly pull the lower leg downward until fluid begins to drain. Continue pulling downward to remove the lower leg from the fork. If the lower leg does not slide off of the upper tube, then the press-fit of the shaft to the lower leg may still be engaged. Reinstall the bottom bolt 2 to 3 turns and repeat steps 9-11.

### NOTICE

Do not hit the fork arch with any tool when removing the lower leg as this could damage the fork.



## Lower Leg Seal Service

- 1 Place the tip of a downhill tire lever underneath the lower lip of the dust wiper seal.

### NOTICE

If using a flat blade screwdriver, make sure it has a round shaft. A screwdriver with a square shaft will damage the fork leg.



- 2 Stabilize the lower leg on a bench top or on the floor. Press down on the tire lever handle to remove the dust wiper seal.

Repeat on the other side.

### NOTICE

Keep the lower leg assembly stable. Do not allow the lower leg to twist in opposite directions, compress toward each other, or be pulled apart. This will damage the lower leg.



- 3 Use your fingers to remove and discard the foam rings inside the lower leg.



- 4 Soak the new foam rings in RockShox® 0w-30 suspension fluid.



- 5** Spray isopropyl alcohol on the inside and outside of the lower leg. Clean the outside of the lower leg with a rag.

Wrap a rag around a long dowel and insert it into each lower leg to clean the inside of the lower leg.



- 6** Reinstall new foam rings on the top bushings in the lower leg.



- 7** Remove the wire spring from the new dust wiper seal and set it aside.



- 8** Insert the narrow end of a new dust wiper seal into the recessed end of the seal installation tool.

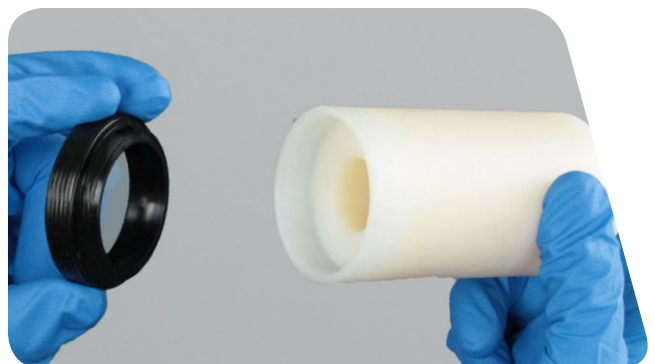

9 Hold the lower leg steady and use the seal installation tool to press the dust wiper seal evenly into the lower leg until the seal surface is flush with the top of the lower leg surface.

Reinstall the wire spring onto the dust wiper seal.

Repeat steps 7, 8, and 9 for the other side of the lower leg.

### **NOTICE**

Only press the dust wiper seal into the lower leg until it is flush with the top surface of the lower leg. Pressing the dust wiper seal past the top surface of the lower leg can damage the foam rings.



### NOTICE

Inspect each part for scratches. Do not scratch any sealing surfaces when servicing your suspension. Scratches can cause leaks.

When replacing seals and o-rings, use your fingers or a pick to remove the seal or o-ring. Spray isopropyl alcohol on each part and clean with a rag. Apply SRAM® Butter to the new seal or o-ring.

- 1 Clamp the non-drive side upper tube into a bicycle stand.



- 2 Use a small hex wrench to depress the Schrader valve and verify all air pressure is removed from the air chamber.

### ⚠ CAUTION - EYE HAZARD

Verify all pressure is removed from the fork before proceeding. Failure to do so can cause the top cap to eject forcefully from the upper tube which can result in injury. Wear safety glasses.



- 3 Use a 24 mm socket to remove the top cap. Spray isopropyl alcohol on the upper tube threads and clean the threads with a rag.





- 4 Use your fingers or a pick to remove the top cap o-ring.  
Use your fingers to install a new o-ring.



- 5 Use a flat head screwdriver to push the seal head tab under the retaining ring.  
Place your finger over the end of the air spring shaft to prevent it from getting scratched while removing the retaining ring.

### NOTICE

Scratches on the air shaft will allow air to bypass the seal head into the lower leg, resulting in reduced spring performance.

Place the tips of large internal snap ring pliers into the eyelets of the retaining ring. Press firmly on the pliers to push the Solo Air™ seal head assembly into the upper tube enough to compress and remove the retaining ring. Slide the retaining ring onto your finger and release the air spring shaft.

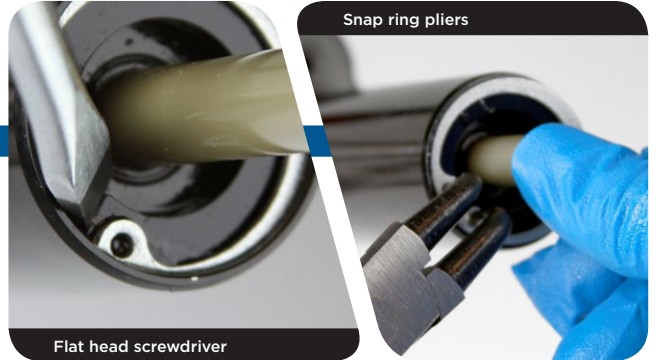

- 6 Use your fingers to install the bottom bolt in the air shaft.  
Firmly pull on the bottom bolt to remove the air shaft assembly from the upper tube. Unthread and remove the bottom bolt from the air shaft.



**7** Spray isopropyl alcohol on the inside and outside of the upper tube and clean it with a rag.

Wrap a rag around a long dowel and insert it into the upper tube to clean inside the upper tube.



**8** Remove the top out spacer, wavy washer, and seal head assembly from the air shaft.

Spray isopropyl alcohol on the seal head assembly and air shaft and clean it with a rag.



**9** Use your fingers or a pick to remove the outer seal head o-rings. Use a pick to pierce and remove the inner o-ring and scraper seal. Use your fingers to install the new o-rings and scraper seal.



**10** Use your fingers or a pick to remove the air piston quad ring and backup rings. Use your fingers to install a new quad ring and backup rings.

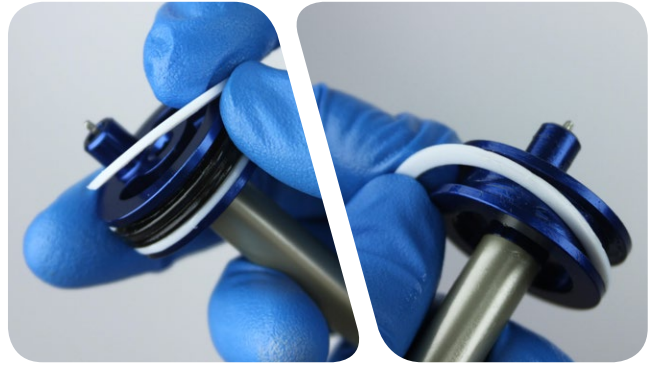

## Solo Air™ Bottomless Token™ Installation

Bottomless Tokens reduce the air volume in your fork to create greater ramp at the end of the fork travel. Add tokens to maintain your fork's bottomless feel. Consult the Bottomless Tokens user manual for the maximum number of tokens for your fork.

- 1 Thread a Bottomless Token into another token or into the the bottom of the top cap. Use an 8 mm hex wrench and a torque wrench with a 24 mm socket to tighten the token to 3.4-4.5 N•m (30-40 in-lb).



## Air Spring Installation

- 1** Apply a liberal amount of SRAM® Butter to the inner o-rings and scraper seal. Install the seal head assembly, wavy washer, and top out spacer onto the air shaft.



- 2** Apply a liberal amount of SRAM Butter to the air piston and seal head.

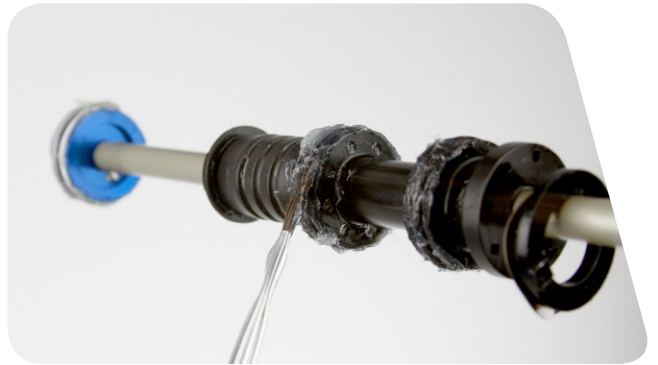

- 3** Firmly push the air shaft and seal head assembly into the bottom of the upper tube while gently rocking the air shaft side to side. Install the wavy washer and top out spacer inside the upper tube.

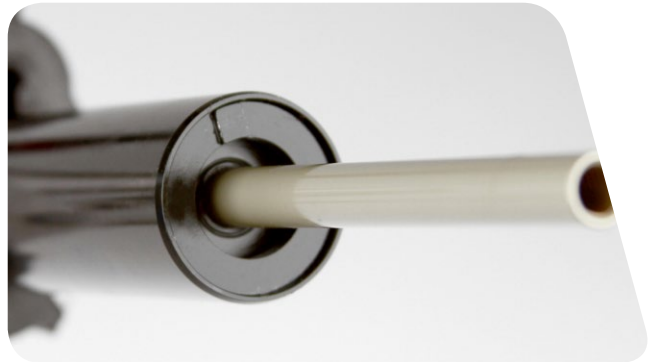

- 4 Use your finger to push the air shaft in to prevent it from getting scratched while installing the retaining ring.

### NOTICE

Scratches on the air shaft will allow air to bypass the seal head into the lower leg, resulting in reduced spring performance.

Place the tips of large internal snap ring pliers into the eyelets of the retaining ring and install the retaining ring into the groove. The tab of the seal head should be positioned between the retaining ring eyelets.

**Check that the retaining ring is properly seated in the retaining ring groove by using the snap ring pliers to rotate the retaining ring and seal head back and forth a few times.**

*Retaining rings have a sharper-edged side and a rounder-edged side. Installing retaining rings with the sharper-edged side facing the tool will allow for easier installation and removal.*



- 5 Insert the top cap into the top of the upper tube. Use a torque wrench with a 24 mm socket to tighten the top cap to 7.3 N·m (65 in-lb).



- 6 Use a shock pump to pressurize the air spring to 30 psi (2.1 bar) to push the air shaft out of the upper tube.



# Charger Damper™ Service

## Charger Damper Removal

### NOTICE

Use aluminum soft jaws to protect the Charger Damper assembly when using a vice.

Inspect each part for scratches. Do not scratch any sealing surfaces when servicing your suspension. Scratches can cause leaks.

When replacing seals and o-rings, use your fingers or a pick to remove the seal or o-ring. Spray isopropyl alcohol on each part and clean with a rag. Apply SRAM® Butter to the new seal or o-ring.

- 1 Clamp the drive side upper tube into a bicycle stand.



- 2 Use a 2 mm hex wrench to remove the knob retaining screw. Remove the low speed compression adjuster knob.



- 3 Use a 24 mm socket to loosen the compression top cap. Remove the Charger Damper assembly from the upper tube. Clean the upper tube threads with a rag.

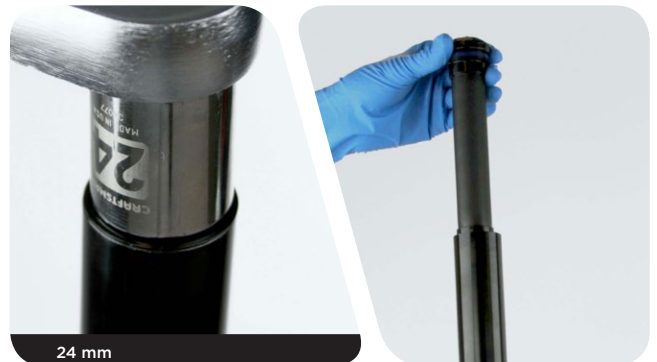

- 4** Use a pick or your fingers to remove the compression top cap o-ring. Install a new compression top cap o-ring.



- 5** Use large internal snap ring pliers to remove the retaining ring from the bottom of the upper tube.



- 6** Insert a long dowel into the top of the upper tube and push the lower seal head out the bottom of the upper tube.





**7** Use your fingers to remove the outer o-ring on the lower seal head. Use a pick to pierce and remove the inner scraper seal from the lower seal head.

Use your fingers to install a new o-ring and scraper seal on the lower seal head.



**8** Remove the drive side upper tube from the bicycle stand.

Clamp the cartridge tube into a bicycle stand with the rebound damper oriented upward.

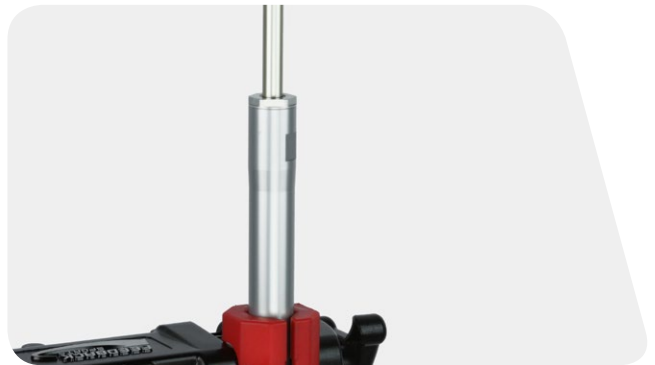

**9** Identify the manufacturing date code on your fork by looking on the back side of the crown. The code is broken up into sections: the first two numbers are the week the fork was made, the letter is the factory code, the following number is the last digit of the year, and the rest of the code is the serial number for the fork. Only the first four digits are important to this step.

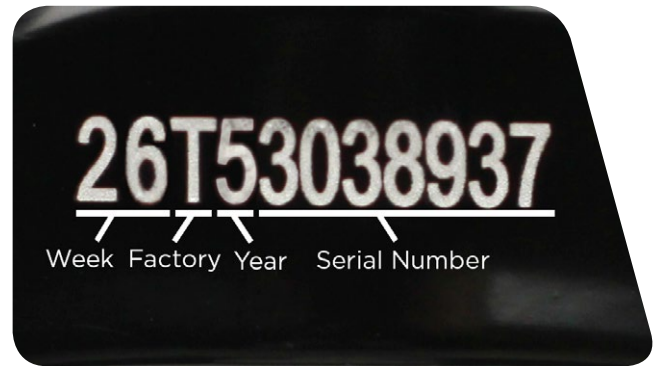

**Manufacturing date code before 26T5:** Place a 21 mm open end wrench on the wrench flats of the cartridge tube. Place another 21 mm open end wrench on the damper seal head.

Holding the cartridge tube in place, turn the damper seal head counter-clockwise to loosen and remove the rebound assembly.



**Manufacturing date code after 26T5:** Place a 21 mm open end wrench on the wrench flats of the cartridge tube. Place a 23 mm open end wrench on the damper seal head.

Holding the cartridge tube in place, turn the damper seal head counter-clockwise to loosen and remove the rebound assembly.

### NOTICE

Forks with a manufacturing date code after **26T5** have the most recent performance upgrades, and it is not necessary to replace the damper components unless they are damaged or worn.

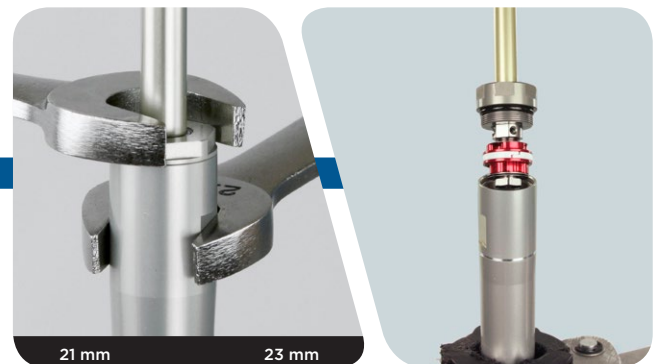

**10** Remove the cartridge tube from the bicycle stand and pour the fluid into an oil pan.



- 11** Remove the rebound damper seal head from the rebound damper shaft.



- 12** Use your fingers to remove the glide ring from the rebound damper piston.  
Use your fingers to install a new glide ring. Set the rebound shaft assembly aside.



- 13** Clamp the wrench flats of the coupler into a vice with the cartridge tube oriented upward.

**NOTICE**

Do not clamp the cartridge tube in the vise.

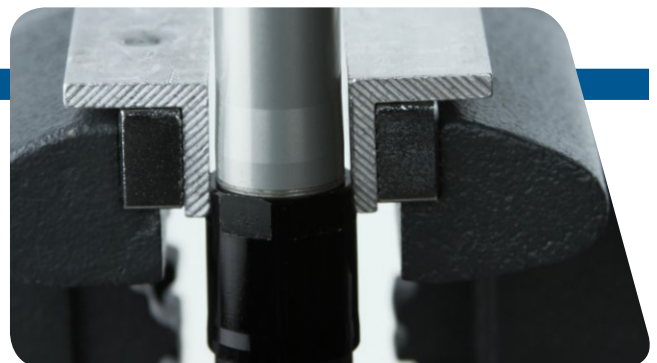

- 14** Place a 21 mm open end wrench on the wrench flats of the cartridge tube. Hold the coupler in place with the vise and turn the wrench counter-clockwise to loosen and remove the cartridge tube from the coupler.  
Set the cartridge tube aside.



**15** Remove the coupler, bladder, and compression top cap assembly from the vise.

While holding it over an oil pan, use needle-nose pliers to remove the compression piston assembly.

*Fluid will spill from the coupler.*

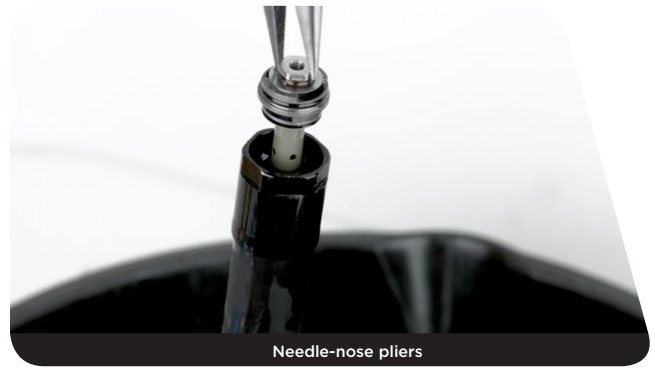

Needle-nose pliers

**16** Pour the fluid into an oil pan.



**17** Clamp the wrench flats of the coupler into a vice with the compression top cap oriented upward.

Use a 6 mm socket to remove the retaining nut from the compression top cap.



6 mm

**18** Use needle-nose pliers to remove the low speed compression adjuster from the compression top cap.



Needle-nose pliers

**19** Use your fingers or a pick to remove the o-ring on the low speed compression adjuster.

Use your fingers to install a new o-ring.



**20** Use your fingers or a pick to remove the o-ring from the compression piston.

Use your fingers to install a new o-ring.



**21** Use your fingers or a 2.5 mm hex wrench to remove the low speed compression needle.

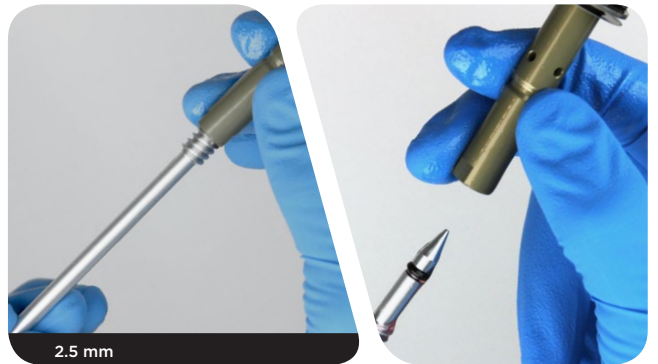

**22** Use your fingers or a pick to remove the o-ring from the low speed compression needle.

Use your fingers to install a new o-ring.



**23** Use a 24 mm socket to loosen and remove either the coupler or the compression top cap from the bladder, whichever loosens first. Remove the assembly from the vise.



**24** Clamp a 5/8" hex bit socket into a vise. If the **compression top cap** came off in step 24, set the bladder on the hex bit socket with the coupler oriented upward. Use a 25 mm open end wrench to remove the coupler. If the **coupler** came off in step 24, set the bladder on the hex bit socket with the compression top cap oriented upward. Use a 24 mm socket wrench to remove the compression top cap. Remove the assembly from the vise.

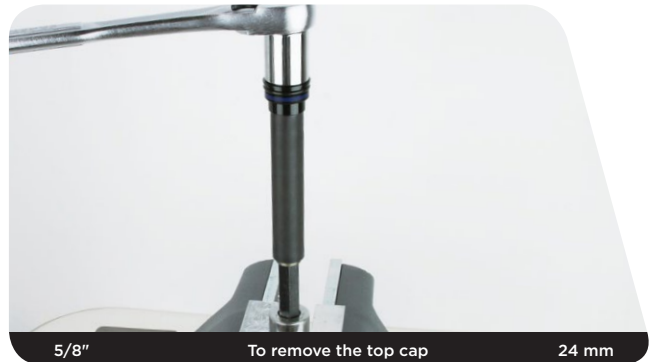

- 25** Use a pick or your fingers to remove the o-ring inside the coupler.  
Use your fingers to install a new o-ring.



- 26** Use your fingers to remove the bladder from the bladder sleeve. Inspect it for tears or cracks. If there are any tears or cracks, replace the bladder.

Spray isopropyl alcohol on the bladder and bladder sleeve and clean them with a rag.



## Optional Charger Damper™ Re-tune

The Charger Damper in BoXXer® comes with additional shims installed on the piston to allow the rider to modify the compression and/or rebound tunes.

If your rebound setting is one or two clicks from open, we recommend changing to a soft tune on the rebound. If your compression setting is one or two clicks from open, we recommend changing to a soft tune on the compression.

Conversely, if your rebound setting is one or two clicks from closed, we recommend changing to a firm tune on the rebound. If your compression setting is one or two clicks from closed, we recommend changing to a firm tune on the compression.

All Charger Dampers in BoXXer ship with the Medium Damper Tune installed.

## Optional Rebound Re-tune

- 1 Clamp the bottom of the rebound damper shaft into a RockShox® Rear Shock Vise Block.

### NOTICE

To prevent damage to the rebound damper shaft, do not clamp the middle of the shaft in the vise.



- 2 Use a 10 mm socket to remove the piston nut. Use your hand to stabilize the rebound damper shaft.

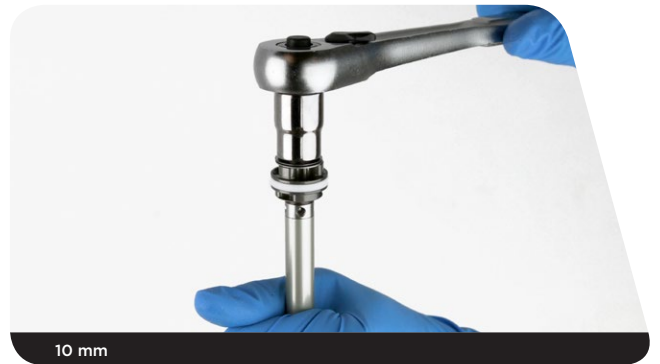

- 3 Use a small wrench or pick to slide the shims off of the rebound damper piston. Set the shims on a rag in the order they came off of the piston.





**4** Use the chart below to layout the shim stack for your desired tune on your rebound damper piston. Use a metric caliper to verify the shim outer diameter and shim thickness or print the page at 100% scale to arrange the shim stack using the outlines on the page.

*All Charger Dampers™ in BoXXer® ship with the Medium Damper Tune installed.*

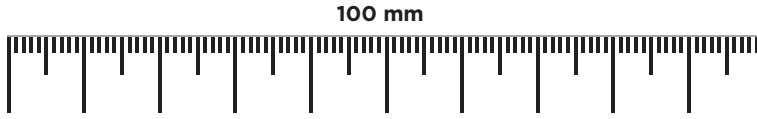

\*Print this page at 100% scale and use the chart to layout your desired rebound tune.

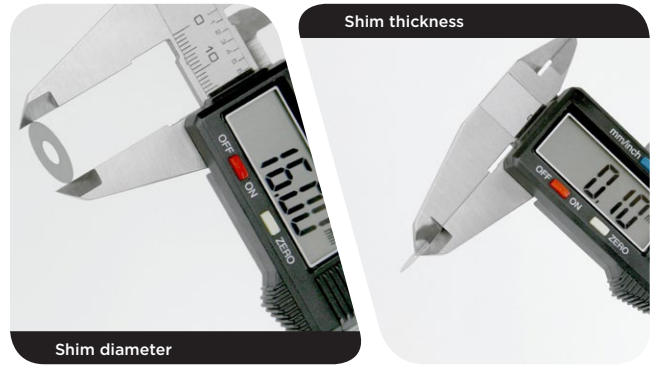

**Soft Rebound Tune**

1:1* Shim Size Outer Dimension (mm)	1:1* Shim Thickness (mm)
8	0.3
12	0.1
14	0.1
16	0.1
8	0.2
16	0.1

Piston Face  
Bottom of stack

16	0.1
14	0.1
16 Hoop	0.2

If using the soft tune, 16 x 6 x 0.1, 14 x 6 x 0.1, and 16 x 14 x 0.2 are not used. Save them so they can be reinstalled if you change your tune to Medium or Firm.

**Medium Rebound Tune (Stock Tune)**

1:1* Shim Size Outer Dimension (mm)	1:1* Shim Thickness (mm)
16	0.1
14	0.1
8	0.2
8	0.3
12	0.1
16	0.1
16 Hoop	0.2
14	0.1
16	0.1

Piston Face  
Bottom of stack

**Firm Rebound Tune**

1:1* Shim Size Outer Dimension (mm)	1:1* Shim Thickness (mm)
8	0.3
14	0.1
16	0.1
8	0.2
12	0.1
16	0.1
16 Hoop	0.2
14	0.1
16	0.1

Piston Face  
Bottom of stack

- 5** Install the shims on a small wrench or pick in the order of your desired tune. Slide the shim stack onto the piston face. Use your fingers to squeeze the stack and center the shims.

**NOTICE**

Ensure the hoop shim is centered on the shim stack.

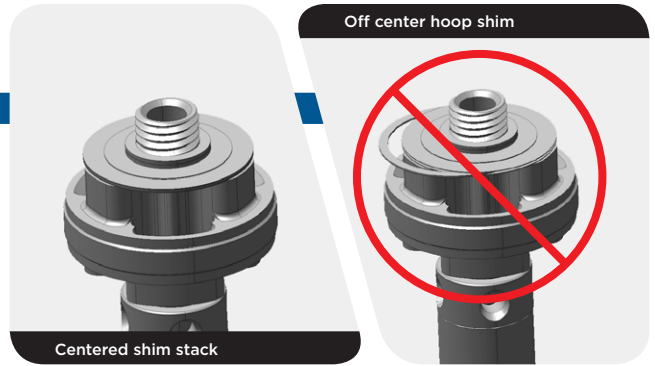

- 6** Thread the main piston nut onto the rebound damper piston. Use a torque wrench with a 10 mm socket to tighten the nut to 3.7 N•m (33 in-lb).

**NOTICE**

Ensure the check shim is centered, and not pinched under the piston.

Remove the assembly from the vise.

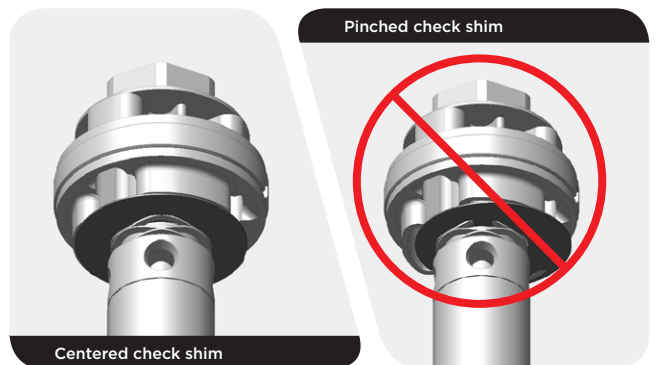

## Optional Compression Re-tune

- 1 Clamp the compression piston shaft into a RockShox® Rear Shock Vise Block.

### NOTICE

To prevent damage to the compression piston, position the shaft in the vise so that the piston is clear of the vise block.

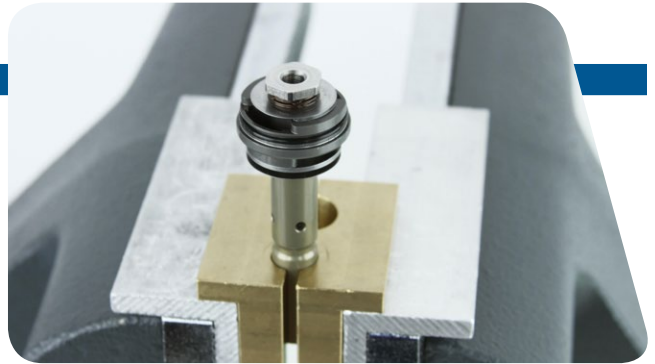

- 2 Use a 10 mm socket to remove the piston bolt.



- 3 Use a small wrench to remove the piston assembly from the compression damper shaft. Set the shims on a rag in the order they came off of the piston.



**4** Use the chart below to layout the shim stack for your desired tune on your compression piston. Use a metric caliper to verify the shim outer diameter and shim thickness or print the page at 100% scale to arrange the shim stack using the outlines on the page.

*All Charger Dampers™ in BoXXer® ship with the Medium Damper Tune installed.*

100 mm



\*Print this page at 100% scale and use the chart to layout your desired rebound tune.

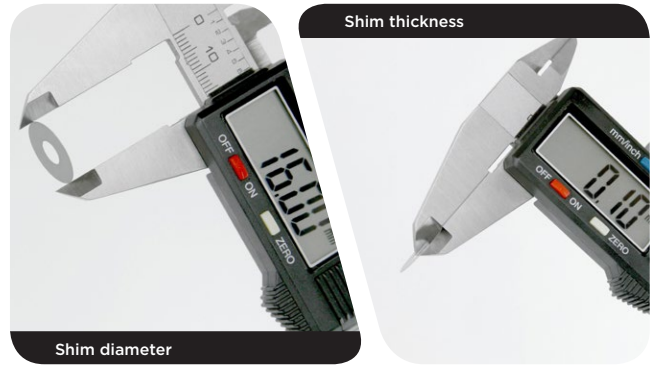

Soft Compression Tune		Medium Compression Tune (Stock Tune)		Firm Compression Tune	
1:1* Shim Size Outer Dimension (mm)	1:1* Shim Thickness (mm)	1:1* Shim Size Outer Dimension (mm)	1:1* Shim Thickness (mm)	1:1* Shim Size Outer Dimension (mm)	1:1* Shim Thickness (mm)
16	0.1	16	0.1	16	0.15
18	0.2	18	0.2	18	0.15
18	0.15	8	0.3	8	0.3
8	0.3	8	0.3	8	0.3
8	0.3	8	0.3	8	0.3
8	0.3	8	0.3	8	0.3
8	0.3	18	0.15	18	0.2
18	0.15	18	0.15	18	0.15
18	0.15	18	0.15	18	0.15
18	0.15	18	0.15	18	0.15
18 Hoop	0.3	18 Hoop	0.3	18 Hoop	0.3
16	0.15	16	0.15	16	0.1
18	0.1	18	0.1	18	0.1

Piston Face/Bottom of stack

Piston Face/Bottom of stack

Piston Face/Bottom of stack

- 5 Apply a small amount of Loctite® Threadlocker Red 2760™ on the compression shaft threads.

**NOTICE**

Do not allow the Loctite to come in contact with the shims.



- 6 Install the shims on a small wrench in the order of your desired tune. Install the piston assembly onto the compression damper shaft. Use your fingers to squeeze the shim stack and center the shims:

**NOTICE**

Ensure the hoop shim is centered on the rest of the shim stack.

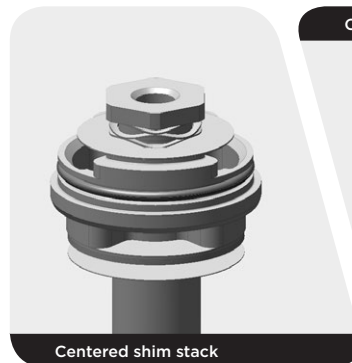

- 7 Thread the piston bolt onto the compression damper shaft. Use a torque wrench with a 10 mm socket to tighten the nut to 3.7 N•m (33 in-lb).

**NOTICE**

Ensure the check shim is centered, and not pinched by the piston bolt.

Remove the assembly from the vise.

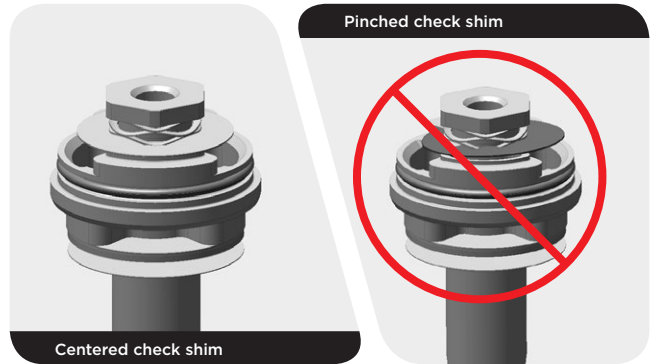
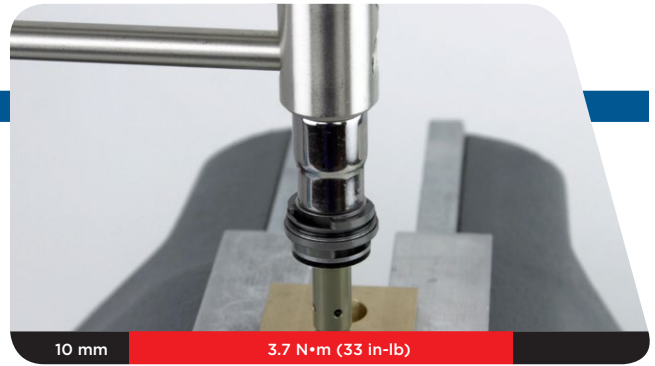

## Charger Damper™ Assembly and Bleed

### NOTICE

Use aluminum soft jaws to protect the Charger Damper assembly when using a vice.

Inspect each part for scratches. Do not scratch any sealing surfaces when servicing your suspension. Scratches can cause leaks.

When replacing seals and o-rings, use your fingers or a pick to remove the seal or o-ring. Spray isopropyl alcohol on each part and clean with a rag. Apply SRAM® Butter to the new seal or o-ring.

- 1 Use your fingers to install the bladder onto the bladder sleeve. Ensure that it is centered between the ends of the sleeve.



- 2 Apply a liberal amount of SRAM Butter onto both ends of the bladder.



- 3 Thread the compression top cap and coupler into either side of the bladder assembly.



- 4** Clamp the wrench flats on the coupler into a vise with the compression top cap facing up.

Use a torque wrench with a 24 mm socket to tighten the compression top cap to 4.5-5.5 N•m (40-50 in-lb).

### NOTICE

Ensure the bladder does not twist during installation. If the bladder starts to twist, unthread the compression top cap and coupler and repeat steps 1-4.



- 5** Spray isopropyl alcohol on the inside and outside of the cartridge tube. Clean the outside of the cartridge tube with a rag.

Wrap a rag around a long dowel and insert it into the cartridge tube to clean inside the cartridge tube.



- 6** Clamp the cartridge tube into a bicycle stand with the threads at the bottom and the wrench flats at the top.





- 7 Install the new seal head assembly onto the rebound damper shaft with the threads oriented toward the piston.

### NOTICE

Failure to replace the old seal head with the new seal head may result in reduced fork performance.

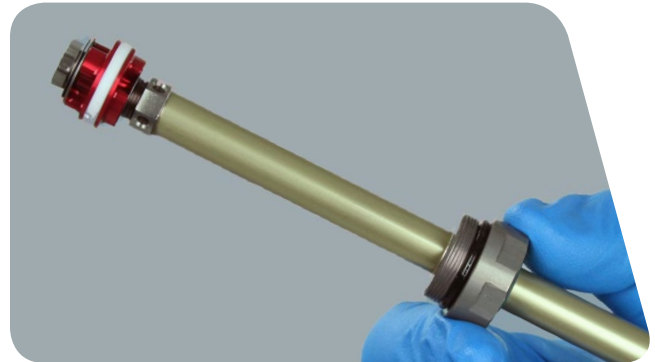
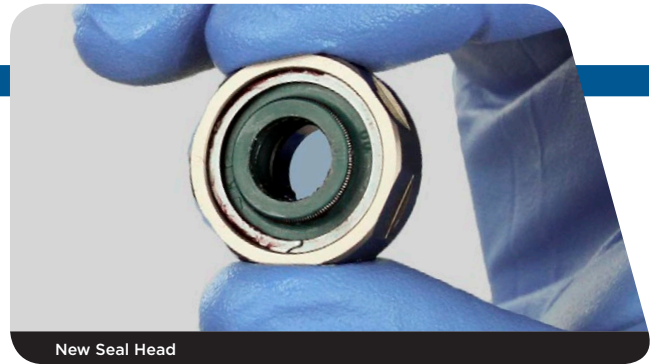

- 8 Lightly clamp the cartridge tube into a bicycle stand with the threads at the bottom and wrench flats at the top. Thread the rebound assembly into the cartridge tube by hand.



- 9 Place a torque wrench with a 23 mm crowfoot open end wrench on the wrench flats on the rebound damper seal head. Place a 21 mm open end wrench on the wrench flats on the damper cartridge tube.

While holding the damper cartridge tube in place, turn the rebound damper seal head clockwise to tighten the rebound assembly to 9-10 N•m (80-90 in-lb).

**Install the crowfoot onto the torque wrench at a 90° angle to the handle to ensure an accurate torque reading.**



- 10** Insert a 2.5 mm hex wrench into the rebound shaft until it contacts the rebound adjuster screw. Turn the hex wrench counter-clockwise until it stops. The rebound adjuster is now in the open position.

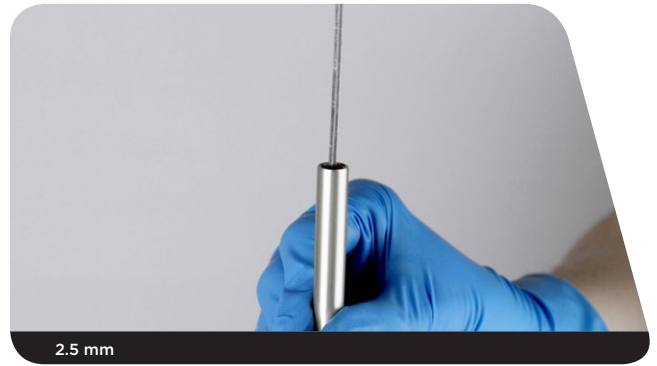

- 11** Remove the cartridge tube assembly from the bicycle stand, turn it over, and clamp the cartridge tube assembly in the bicycle stand so the rebound shaft is oriented downward. Pull down on the rebound shaft.

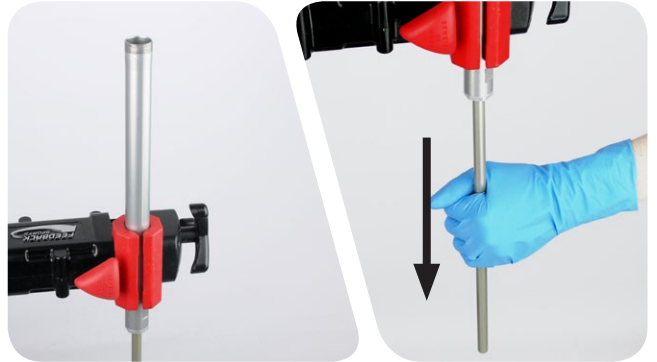

- 12** Pour RockShox® 3wt suspension fluid into the cartridge tube until it is approximately half full.

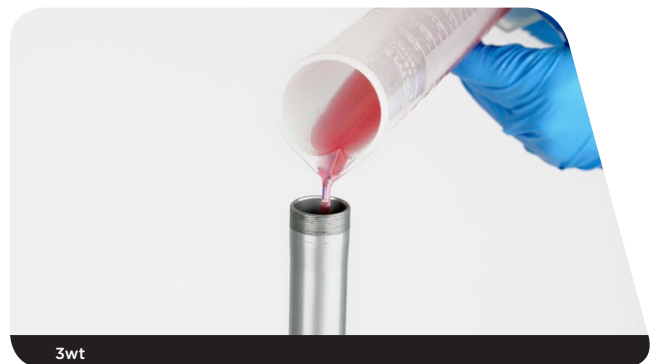

**13** Use the palm of your hand or a rag to cover the cartridge tube, and cycle the damper rebound shaft a few times to help pre-bleed air from the damper.

Pour additional RockShox® 3wt suspension fluid into the cartridge tube until the fluid is level with the top of the tube.

Use your finger to remove any air bubbles from the surface of the fluid.

**⚠ CAUTION - EYE HAZARD**

Pull the rebound damper shaft down slowly. Failure to do so can result in fluid ejecting from the cartridge tube. Wear safety glasses.

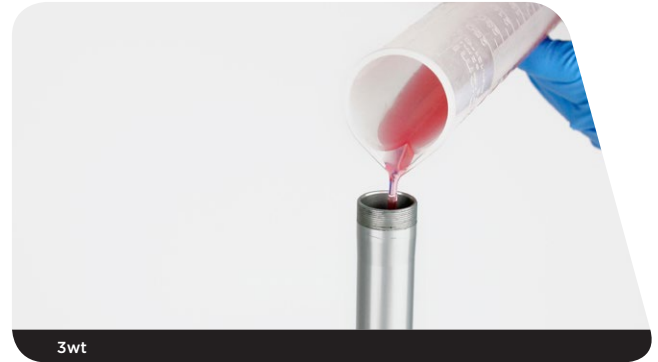
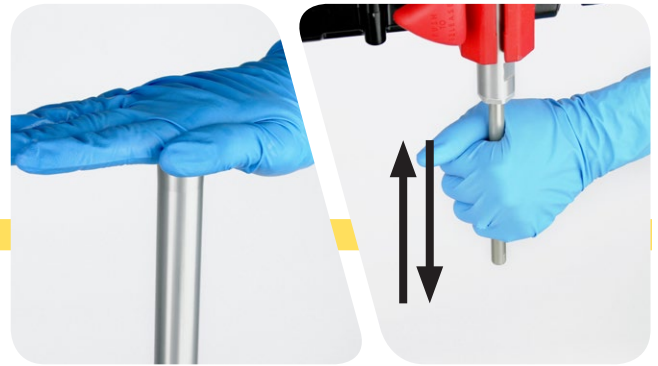

**14** Insert the low speed compression needle into the compression piston assembly. Use your hand or a 2.5 mm hex wrench to turn the needle clockwise until it stops, and then unthread it a 1/2 turn.

Wrap a rag around the cartridge tube. Insert the compression piston assembly into the cartridge tube.

**NOTICE**

Failure to unthread the needle a 1/2 turn will prevent the fork from performing properly.



**15** Spray isopropyl alcohol on the cartridge tube threads and clean the threads with a rag.

Spray isopropyl alcohol on the threads inside the coupler and clean the threads with a rag.



- 16 Apply a small amount of Loctite® Threadlocker Blue 242™ on the coupler threads.

**NOTICE**

Do not allow the Loctite to come in contact with the o-rings or bladder.



- 17 Thread the coupler onto the cartridge tube by hand.

Place a torque wrench with a 25 mm crowfoot open end wrench on the wrench flats of the coupler. Place a 21 mm open end wrench on the wrench flats on the damper cartridge tube.

While holding the damper cartridge tube in place, tighten the coupler to 9-10 N•m (80-90 in-lb).

**Install the crowfoot onto the torque wrench at a 90° angle to the handle to ensure an accurate torque reading.**



- 18 Pour RockShox® 3wt suspension fluid into the compression top cap until it is approximately half full.

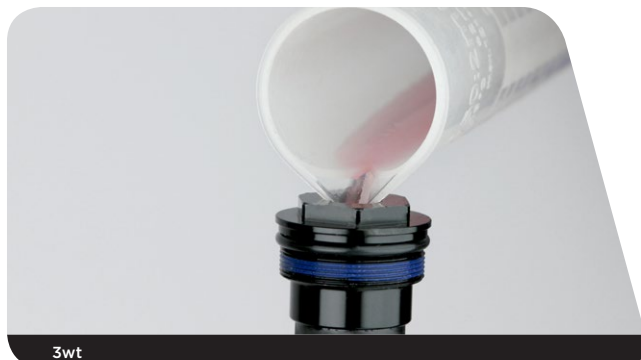

**19** Use the palm of your hand or a rag to cover the compression top cap, and cycle the rebound damper shaft a few times to help pre-bleed air from the damper.

Pour additional RockShox® 3wt suspension fluid into the compression top cap until the fluid is level with the top.

Use your finger to remove any air bubbles from the surface of the fluid.

**⚠ CAUTION - EYE HAZARD**

Fluid may be ejected from the damper top cap assembly. Wear safety glasses.

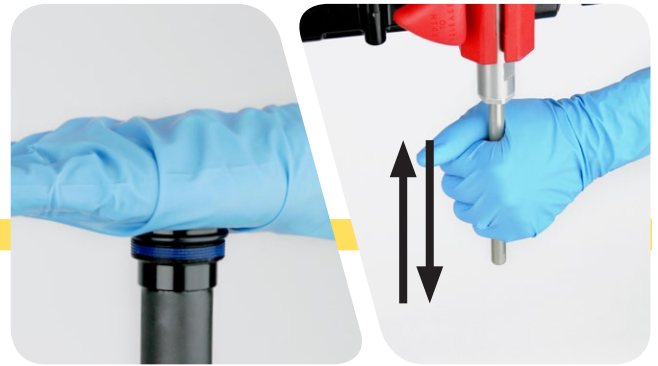

**20** Fully extend the rebound damper shaft by pulling down on the rebound damper shaft.

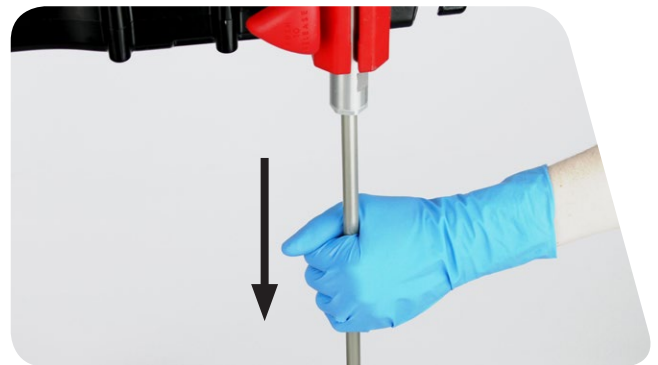

**21** Fill the bleed syringe 1/3 full with 3wt suspension fluid and thread the syringe into the compression top cap.



**22** Create a vacuum in the damper assembly by pulling up on the syringe handle and simultaneously pushing up on the rebound damper shaft. This will force bubbles out of the damper assembly.

Pressurize the damper assembly by pushing down on the syringe handle and simultaneously pulling down on the rebound damper shaft.

Continue to hold down on the syringe handle and simultaneously cycle the rebound damper shaft a few times to purge bubbles.

*The bladder will expand and contract. This is normal.*

Repeat pulling a vacuum and pressurizing the damper assembly until only very small bubbles emerge from the damper assembly.

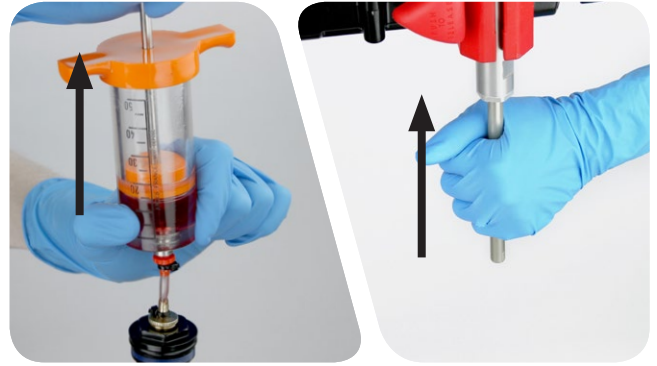

**23** Make sure the rebound damper shaft is fully extended by pulling down on the shaft.

Push the syringe handle down and release it. Allow the bladder to come to its natural resting position by waiting a few moments until the syringe stops filling.

Use a rag to cover the syringe tip and compression top cap bleed port, then unthread and remove the syringe.

**⚠ CAUTION - EYE HAZARD**

Fluid may be ejected from the damper top cap assembly if the bladder is not in its resting position. Wear safety glasses.



**24** Install the low speed compression adjuster into the compression top cap by hand.



**25** Install the compression top cap retaining nut by hand. Use a torque wrench with a 6 mm socket to tighten to 4.8 N•m (42 in-lb).



**26** Spray isopropyl alcohol on the Charger Damper™ assembly and clean it with a rag.

**27** Insert the Charger Damper assembly into the top of the upper tube that has the BoXXer® graphic printed on it. Use a torque wrench with a 24 mm socket to tighten the compression top cap to 7.3 N•m (65 in-lb).



**28** Apply SRAM® Butter to the scraper in the lower seal head and install it onto the rebound shaft with the flat side of the lower seal head facing the upper tube. Push the lower seal head into the bottom of the upper tube.

Push the rebound damper shaft into the upper tube to prevent it from getting scratched while installing the retaining ring.

### NOTICE

Scratches on the rebound shaft will allow oil to bypass the seal head into the lower leg, resulting in reduced performance.

Place the tips of large internal snap ring pliers into the eyelets of the retaining ring and install the retaining ring into the groove.

**Check that the retaining ring is properly seated in the retaining ring groove by using the snap ring pliers to rotate the retaining ring and seal head back and forth a few times, then firmly pull down on the rebound shaft.**

*Retaining rings have a sharper-edged side and a rounder-edged side. Installing retaining rings with the sharper-edged side facing the tool will allow for easier installation and removal.*

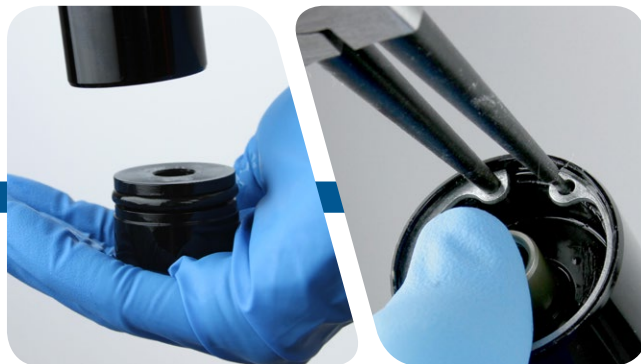

**29** Install the low speed compression adjuster knob and knob retaining screw. Use a torque wrench with a 2 mm hex bit socket to tighten the screw to 1-1.5 N•m (8-13 in-lb).



2 mm

1-1.5 N•m (8-13 in-lb)



## Lower Leg Assembly

- 1 Spray isopropyl alcohol on the upper tubes and clean them with a rag.



- 2 Apply a liberal amount of SRAM® Butter to the inner surfaces of the dust wiper seals.



- 3 Slide the upper tube with the Charger Damper™ into the drive side lower leg just enough to engage the upper bushing with the upper tube.

Slide the upper tube with the air spring into the non-drive side lower leg just enough to engage the upper bushing with the upper tube.

### NOTICE

Make sure both dust wiper seals slide onto the tubes without folding the outer lip of either seal.



- 4 Clamp the upper tube into a bicycle stand. Position the fork at a slight angle with the lower leg bolt holes oriented upward. Angle a syringe fitting in each lower leg bolt hole so the fluid will only contact the inside of the lower leg.

Inject 10 mL of RockShox® 0w-30 suspension fluid into the drive side lower leg, and 10 mL of RockShox 0w-30 suspension fluid into the non-drive side lower leg.

### NOTICE

Do not exceed the recommended fluid volume per leg as this can damage the fork. Do not let fluid fill the rebound shaft.



10 mL

RockShox 0w-30 suspension fluid

- 5** Slide the lower leg assembly along the upper tubes until it stops and the spring and damper shafts are visible through the lower leg bolt holes.

Use a rag to clean the outer surface of the lower leg.



- 6** Install a new crush washer retainer and crush washer on the non-drive side and drive side bottom bolts.

**NOTICE**

Dirty or damaged crush washers can cause leaks.

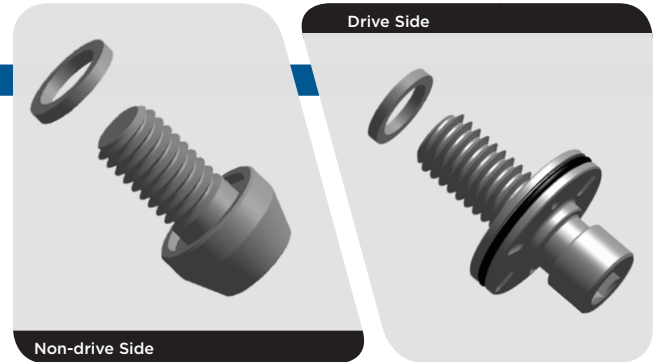

- 7** Thread the black bottom bolt into the non-drive side shaft of the lower leg. Thread the silver bottom bolt into the drive side shaft of the lower leg.

Use a torque wrench with a 5 mm hex bit socket to tighten the bolts to 7.3 N·m (65 in-lb).

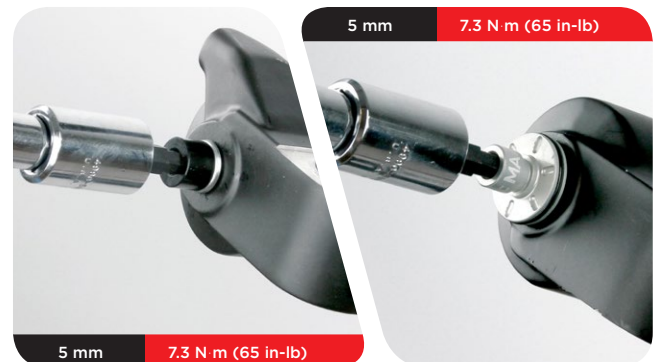

- 8** Install the rebound adjuster knob onto the drive side bottom bolt.

Use a torque wrench with a 2.5 mm hex bit socket to tighten the set screw to 1.1 N·m (10 in-lb).

**NOTICE**

Make sure to hold the rebound adjuster knob in place during installation of the set screw to prevent damage to the bottom bolt.



- 9** Refer to your pre-service recorded settings to pressurize your air spring, or use the air chart on the fork's lower leg and pressurize the air spring to the appropriate pressure for your rider weight.

*You may see a drop in the indicated air pressure on the pump gauge while filling the air spring; this is normal. Continue to fill the air spring to the recommended air pressure.*



- 10** Thread the air valve cap onto the top cap of the non-drive side fork leg until it stops.

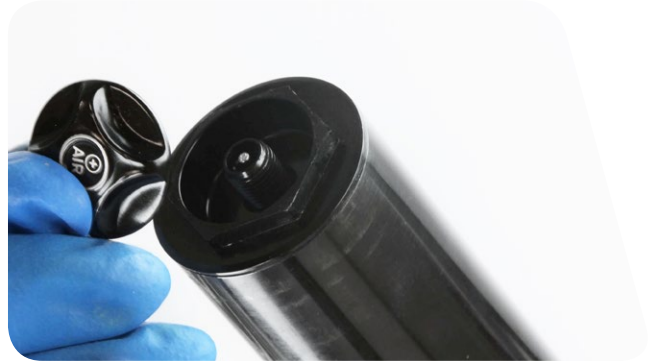

- 11** Spray isopropyl alcohol on the entire fork and clean it with a rag.

## Fork Installation

- 1 Slide each upper tube through the lower crown. Leave enough clearance between the upper tube and the upper crown to install the frame bumpers. Use a 4 mm hex wrench to tighten one of the lower crown bolts to temporarily hold the tubes in place while you install the bumper.

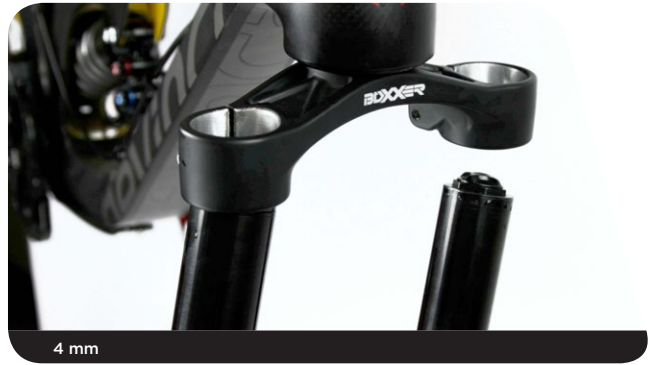

- 2 Spray isopropyl alcohol or water on the inner surfaces of each frame bumper and upper tube. Reinstall the frame bumpers onto the upper tubes.



- 3 Push and twist the upper tubes through the upper crown until both upper tubes extend past the top of the upper crown by an equal amount and at least 2 mm.  
Measure the distance from the top of the upper tube to the top of the lower crown. This distance must be 156 mm (+/- 2 mm).



- 4 Align the BoXXer® logo on the drive side upper tube with the RockShox® logo on the lower leg.



- 5** Use a torque wrench with a 4 mm hex bit socket to tighten the top bolt on the lower crown to 5 N•m (44 in-lb). Use a 4 mm hex bit socket to tighten the bottom bolt on the lower crown to 5 N•m (44-lb). Tighten the top bolt to torque once more, and then tighten the bottom to torque again.

Repeat this tightening procedure for the bolts on the other side of the lower crown.



- 6** Use a torque wrench with a 4 mm hex bit socket to tighten the two upper crown pinch bolts to 5 N•m (44 in-lb).



- 7** **27.5" fork:** Use a 2.5 mm hex wrench to install the brake hose in the hose brace on the fork arch.

**26.5" fork:** Use a cable tie to connect the brake hose to the fork arch.

Install the brake caliper according to the brake manufacturer's instructions.

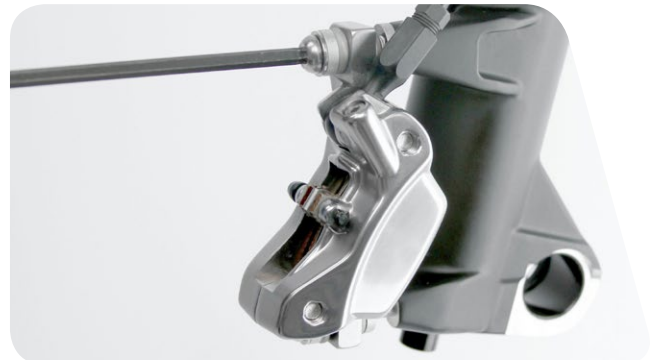

- 8** Position the front wheel in the lower leg dropouts so the hub is seated in the dropouts.

### NOTICE

Verify no parts interfere with the lower leg. Consult your brake manufacturer's instructions if you need to adjust your disc brakes.



**9** Install the threaded end of the Maxle Lite DH™ through the drive side of the hub until it engages the threads of the lower leg dropout.

Use a torque wrench with a 6 mm hex bit socket to tighten the drive side axle bolt to 5.7 N•m (50 in-lb).

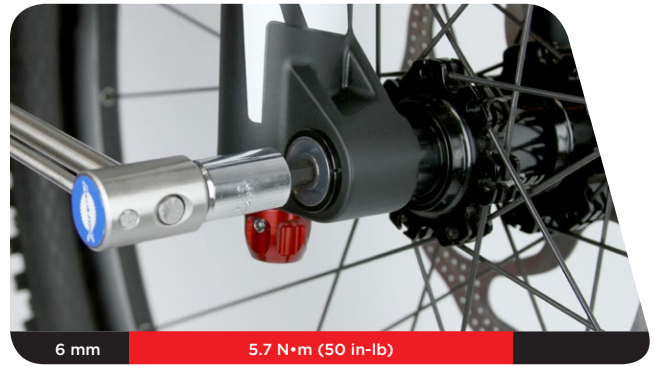

**10** Use a torque wrench with a 6 mm hex bit socket to tighten the non-drive side axle bolt to 3.4 N•m (30 in-lb).



**11** Refer to your pre-service recorded settings to adjust the rebound and compression settings on the fork.



**12** Spray isopropyl alcohol on the entire fork and clean it with a rag.

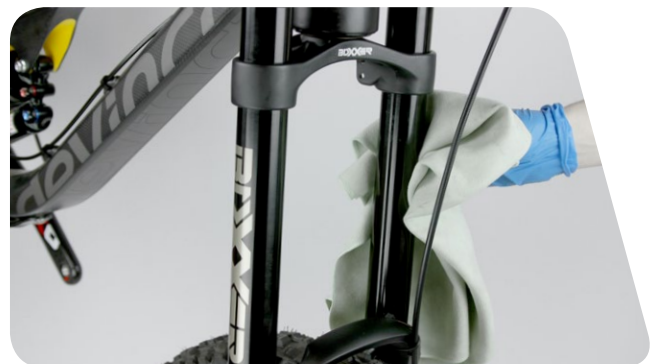

**This concludes the service for RockShox® BoXXer® front suspension forks.**

This publication includes trademarks and registered trademarks of the following companies:

Loctite® is a registered trademark of Henkel Corporation

# **SRAM**<sup>®</sup>

[www.sram.com](http://www.sram.com)



ASIAN HEADQUARTERS  
SRAM Taiwan  
No. 1598-8 Chung Shan Road  
Shen Kang Hsiang, Taichung City  
Taiwan R.O.C.

WORLD HEADQUARTERS  
SRAM LLC  
1000 W. Fulton Market, 4th Floor  
Chicago, Illinois 60607  
USA

EUROPEAN HEADQUARTERS  
SRAM Europe  
Paasbosweg 14-16  
3862ZS Nijkerk  
The Netherlands